

# Assembly Instructions 40' Wide System

## NEW CENTURY® TENT

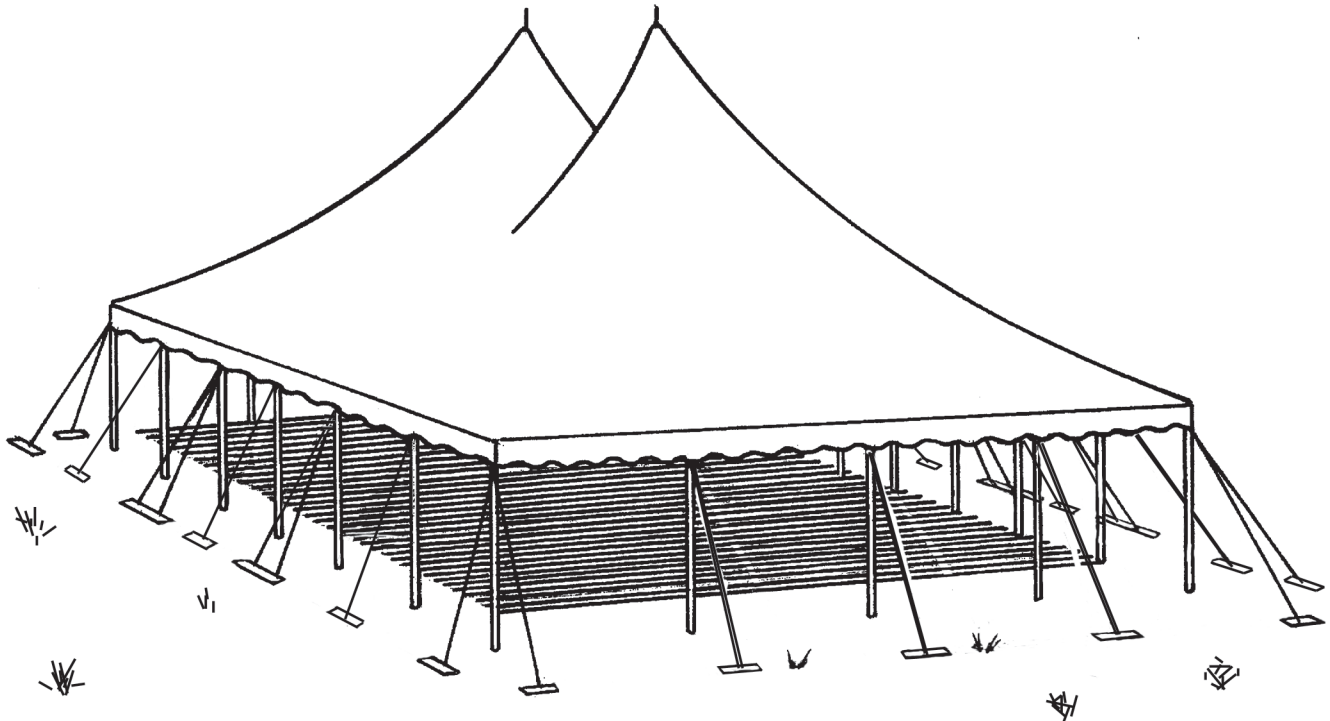

Please read all assembly / installation instructions before the installation or removal of this product.

**SALES OFFICES:**  
1100 BURCH DRIVE  
PO BOX 3477  
EVANSVILLE, IN 47733 USA

PHONE: 812-867-2421  
FAX: 812-867-0547  
1-800-544-4445  
EMAIL: [tents@anchorinc.com](mailto:tents@anchorinc.com)  
[www.anchorinc.com](http://www.anchorinc.com)

**PRODUCTION FACILITY:**  
EVANSVILLE, IN

WEB  
EC4435

*Quality, Craftsmanship and Service since 1892*

40CEN 0911

**IMPORTANT:**

The installation of this Century Tent should be performed/supervised by knowledgeable tent installers with a clear understanding of safety issues as well as the methods of anchoring. The requirements as specified with blue print (supplied by Anchor Industries Inc.) must be followed. The installer/owner must read the assembly instructions completely prior to any installation. Particular attention must be given to anchoring! See Caution Statement on back page of this manual.

**MANPOWER REQUIRED**

Five experienced installers should be able to assemble a 40' x 60' tent in approximately four hours.

**TOOLS REQUIRED**

- Sledge Hammers
- Stake Driver
- 2 Measuring Tapes

**INSPECT SITE**

**Caution:**

Consult your local utility locator service or the National Utility Locating Contractors Association (NULCA) prior to installation. Prior to actual tent assembly, be sure to look up, down, above & below for obstacles, pipes, wires, trouble, etc.

**LAYOUT & CHECK**

Utilize parts list for a quick I.D. and a check list to ensure that you have all the parts.

**Parts Illustrations**

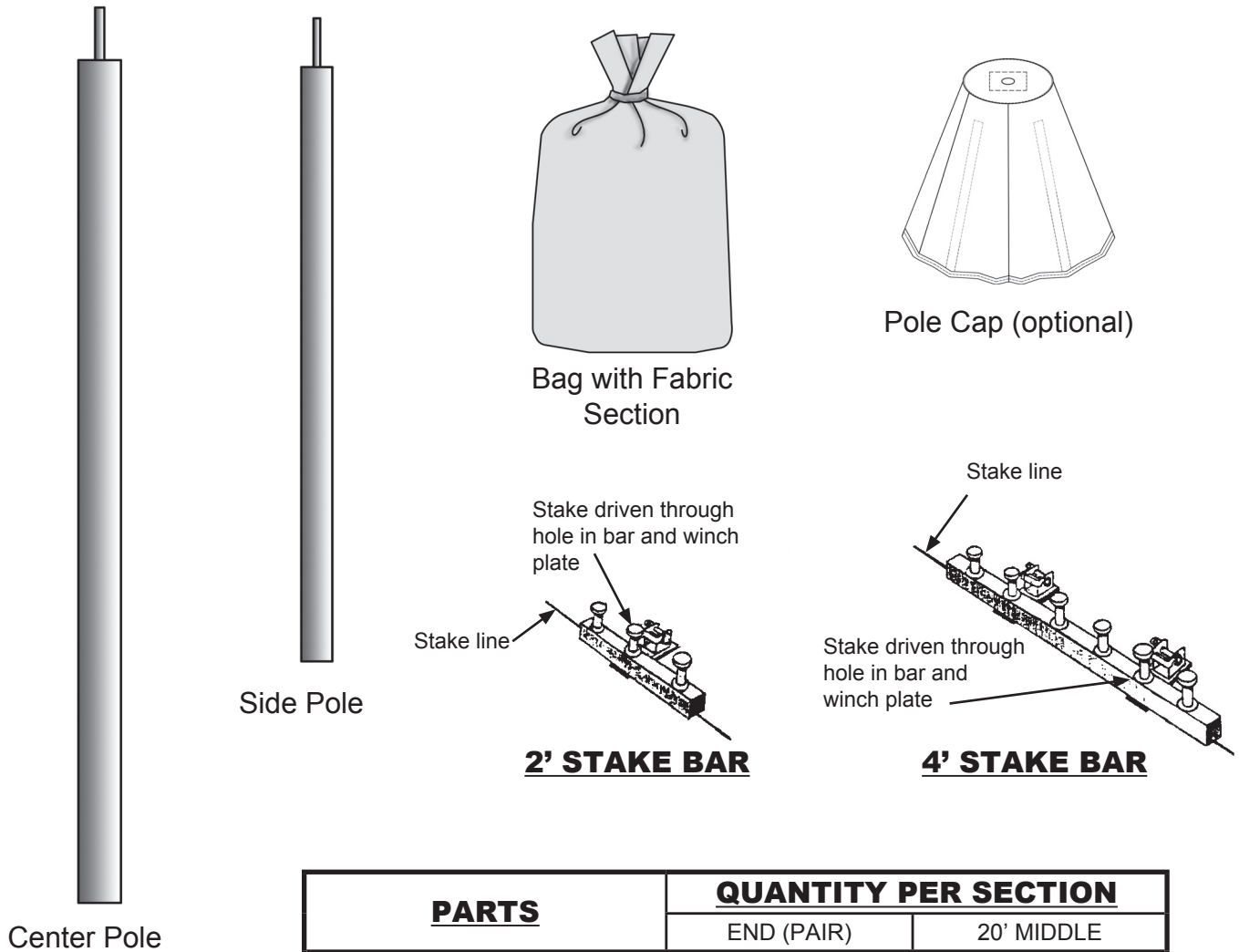

<b><u>PARTS</u></b>	<b><u>QUANTITY PER SECTION</u></b>	
	<b>END (PAIR)</b>	<b>20' MIDDLE</b>
BAG WITH FABRIC SECTION	2	1
CENTER POLE	1	1
SIDE POLE	16	4
POLE CAP (OPTIONAL)	1	1
SEE WEB GUY LAYOUTS & STAKING TABLES FOR STAKING REQUIREMENTS.		

# 1 WEB GUY LAYOUT \*



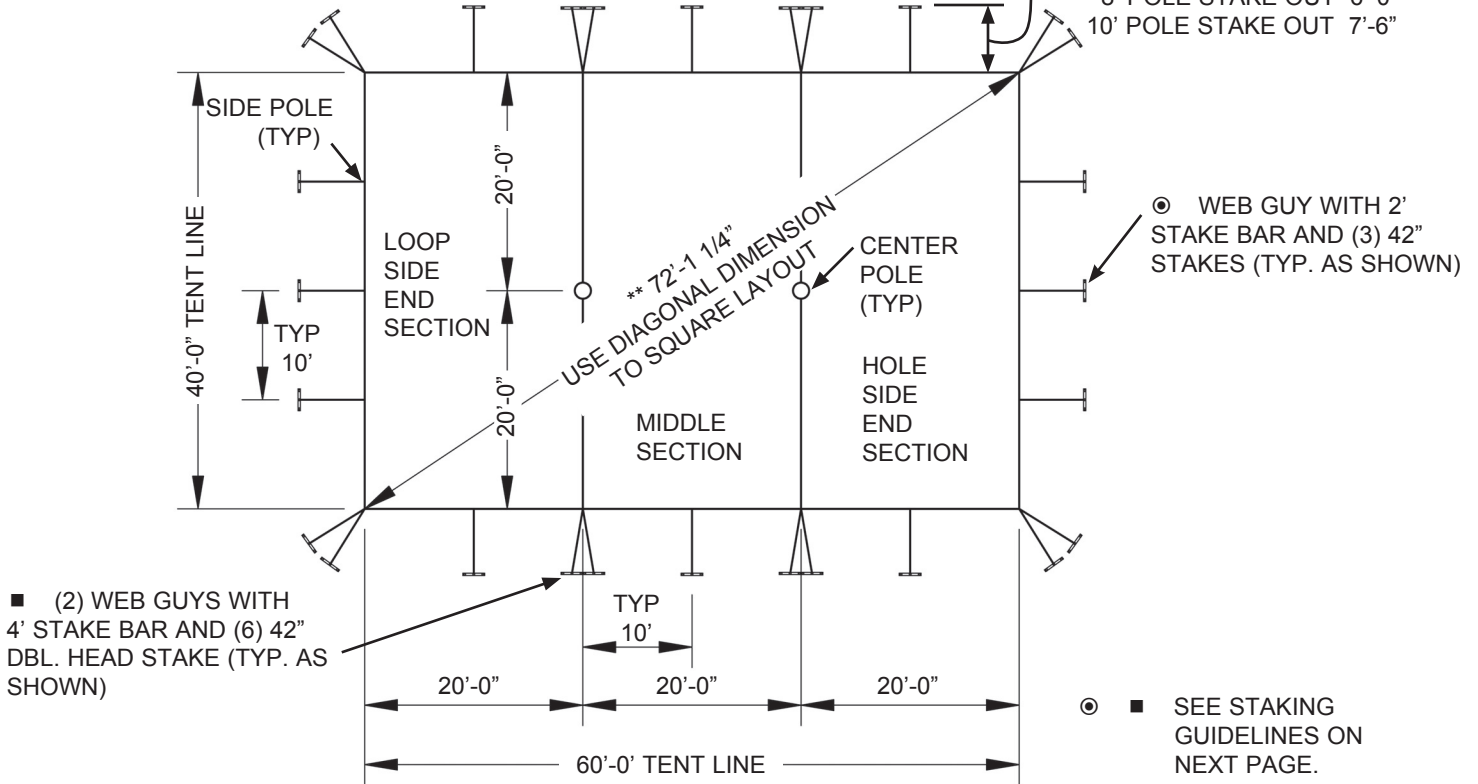

## MARK LOCATION OF STAKES, SIDE POLES & CENTER POLES

\*\* To find diagonal measurement:  
 $diagonal = \sqrt{width^2 + length^2}$

REQUIRED DISTANCE BETWEEN  
 SIDE POLES AND STAKE LINES:  
 7' POLE STAKE OUT 5'-3"  
 8' POLE STAKE OUT 6'-0"  
 10' POLE STAKE OUT 7'-6"

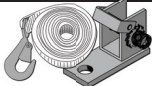

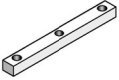
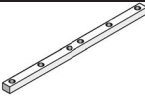
### Staking Table

Illustration	Item No.	Description	Qty. for 40' x 40' (2) Ends	Qty. for 20' Mid
	23000	Century Guy w/ Winch	22	6
	37020A 3704242 (over 25)	42" Double Hd. Stake	66*	18*
	33000	2'-0" Stake Bar w/ (3) Holes	18	2
	33100	4'-0" Stake Bar w/ (6) Holes	2	2
	23100	Winch Tool	2	0

\* **IMPORTANT NOTE:** REFER TO CAUTION STATEMENT #2 FOR IMPORTANT WARNING ABOUT NUMBER OF STAKES SUPPLIED. (SEE BACK PAGE OF THIS MANUAL)

**THE INSTALLER MUST USE THE LOCAL SOIL CONDITIONS TO CALCULATE THE ACTUAL NUMBER OF STAKES REQUIRED AND IS RESPONSIBLE FOR THE STAKING PATTERN AND CONFIGURATION.** ANCHOR PROVIDES ANCHORING PACKAGES FOR COMMON SOIL CLASSIFICATIONS; CONTACT YOUR TENT SALES REPRESENTATIVE FOR MORE INFORMATION.

# STAKING GUIDELINES

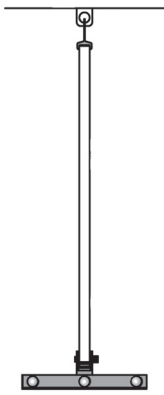

⊙ (1) WEB GUY WITH 2' STAKE BAR AND (3) 42" DOUBLE HEAD STAKES

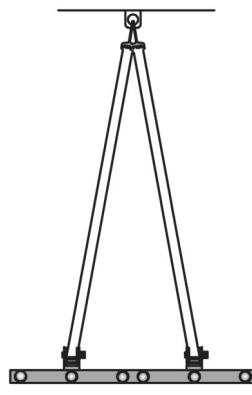

■ (2) WEB GUYS WITH 4' STAKE BAR AND (6) 42" DOUBLE HEAD STAKES

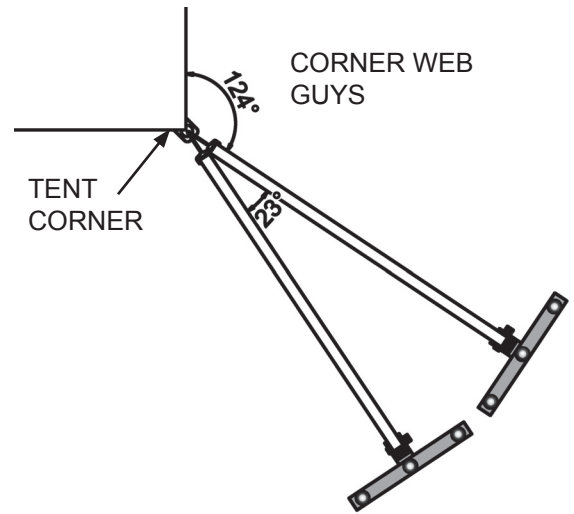

(2) WEB GUYS WITH (2) 2' STAKE BARS AND (6) 42" DOUBLE HEAD STAKES

## 2 LAYOUT AT SITE

Drive stakes at points located. Each 2' stake bar requires 3 stakes. A 4' stake bar requires 6 stakes.

Spread drop cloths and unroll tent.

Any objects with sharp projections which must remain on site under the tent should be padded and taped.

NOTE: Both Loop side and hole side of sections are required for proper lace.

## 3 LACING INSTRUCTIONS

With tent sections on ground, overlap center pole holes with grommet side on top.

Lace between center pole holes first. Push first loop up through corresponding grommet. Continue, passing each loop through a grommet and the preceding loop.

Continue lacing process and cover lacing with protective rain flaps by velcroing the short flap first, then snapping the top flap to the rope as you move toward other center pole hole.

Tie off last long loop.

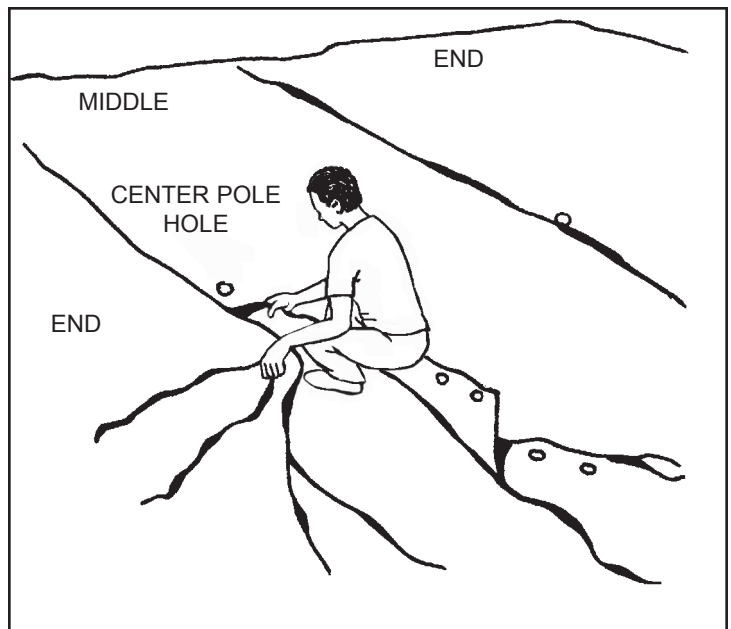
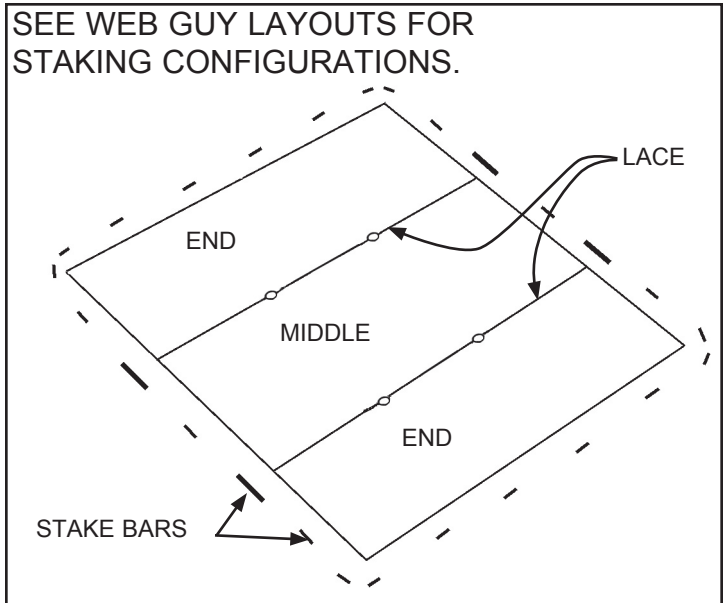

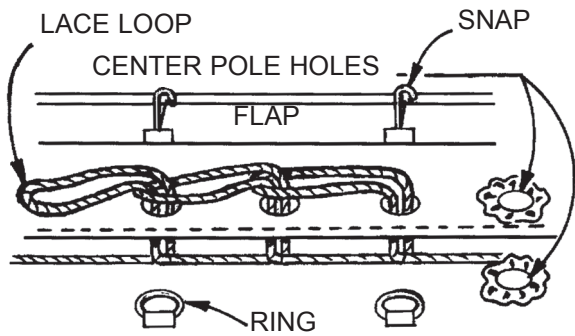

Then lace from center pole to eave on both sides of tent. Tie off last long loop. Align plates and attach hook to plates on inside of tent, as shown.

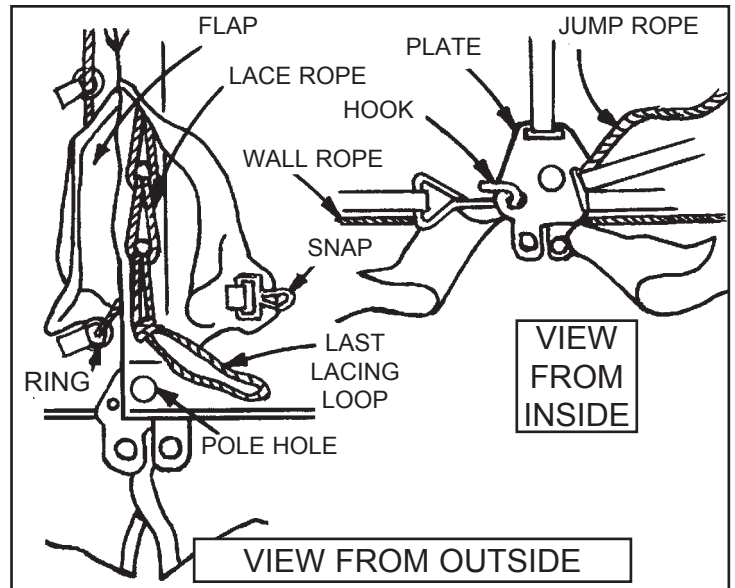

#### 4 POLE CAP (Optional)

Overlap the pole hole plates in the mid and end fabric lace line. Push fabric and plates up into cap and secure from underneath by threading the female, flanged pipe coupling onto the male pipe fitting molded to the inside top of the pole cap.

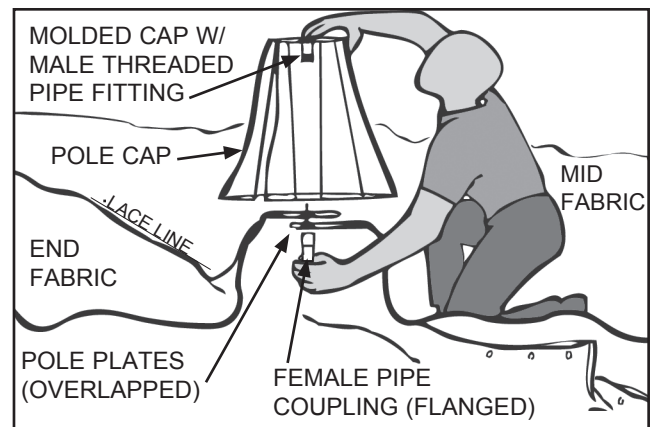

#### 5 TIE DOWN AFTER LACING

After lacing and snapping sections, attach guys and insert loosely into tension winches.

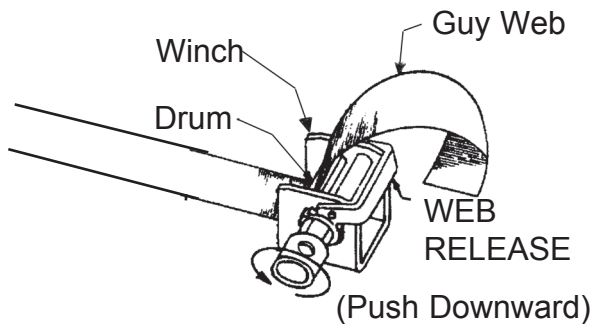

Insert guy web into slot in winch drum and rotate 1 1/2 to 2 times to secure web.

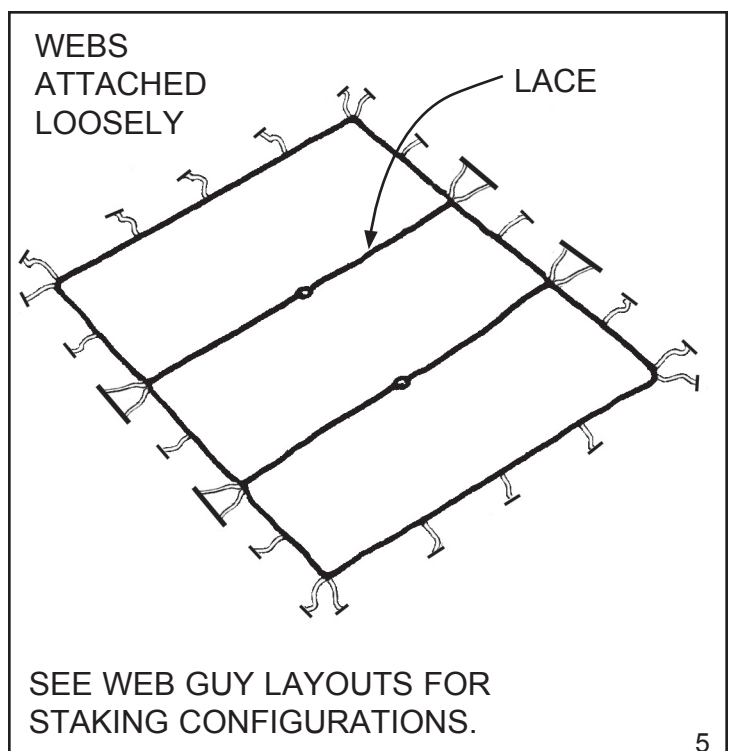

## 6 RAISE SIDE POLES

Start at downwind side. Insert each side pole pin into side pole hole and raise slightly less than perpendicular.

Bottom of each pole should be pointed inward toward center of tent.

Wall ropes should run outside of corner poles and side poles.

Tie jump rope around each side pole as it is inserted in pole hole.

Continue around tent.

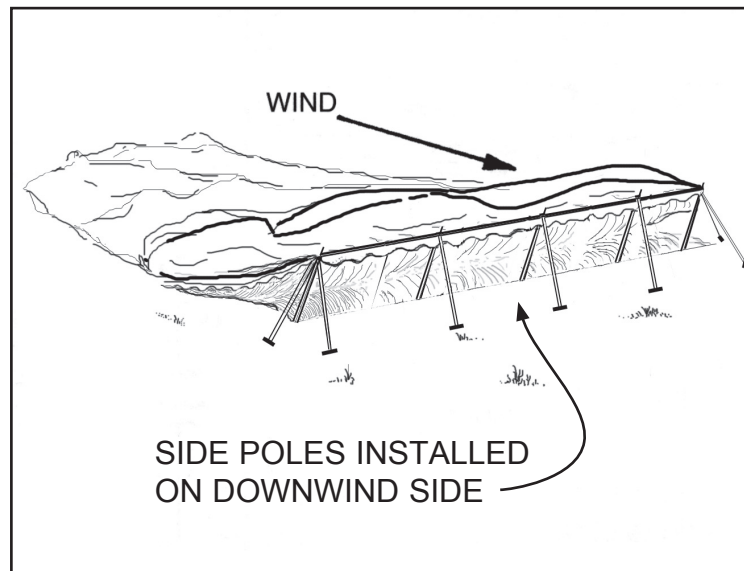

## 7 RAISE CENTER POLES

Raise center poles nearest to wind direction to approximate position.

One installer to guide center pole pin through hole to prevent snagging or tearing of fabric as pole is being raised to position.

Keep pole at a slant until other pole at the same lace is raised. Tie jump ropes as each center pole is placed in approximate position. Adjust bases of poles to exact location and align poles vertically.

**CAUTION:** At this point, it is required to properly anchor bases of all center poles to prevent movement.

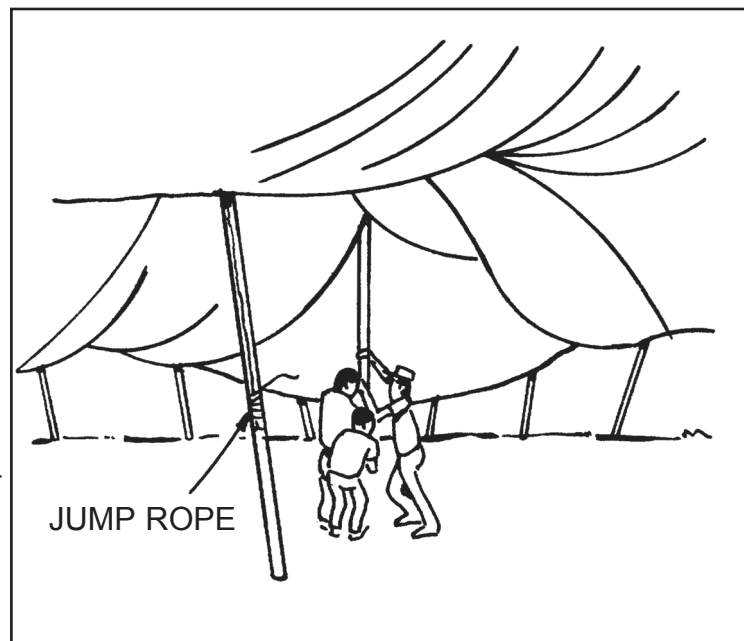
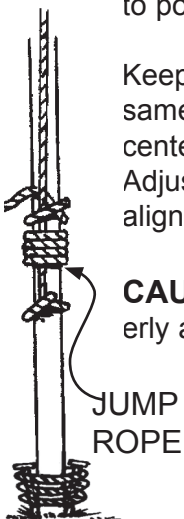

## 8 WINCH FOR TENSION

If the footprint of the tent has been laid out properly and the tent placed squarely within that footprint, the following tensioning sequence is recommended for the best overall appearance:

1. Tension webs at the lace lines first.
2. Tension webs at the corners.
3. Tension webs at the ends.
4. Tension webs at the middles last.

NOTE: If the tent is not square, or if center poles lean when laces are tensioned, reverse steps "1" and "2" above.

At each side pole, release winch tension and place bottom of side pole at the marked footprint eave line location.

Insert guy web into winch. Pull excess through winch. Tension, using winch bar. DO NOT USE EXTENDERS ON WINCH BAR TOOL.

CAUTION -- DO NOT OVER TENSION TENT BEYOND EAVE LINE. DO NOT PULL SIDE POLES OR CENTER POLES BEYOND VERTICAL POSITION.

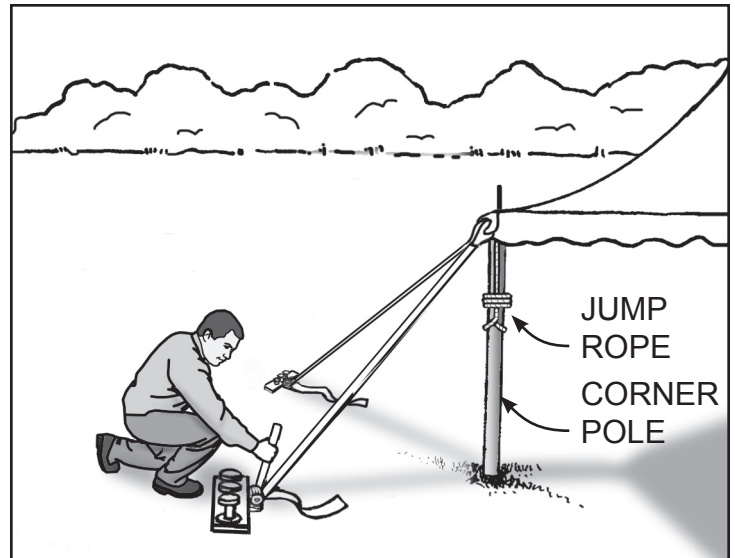
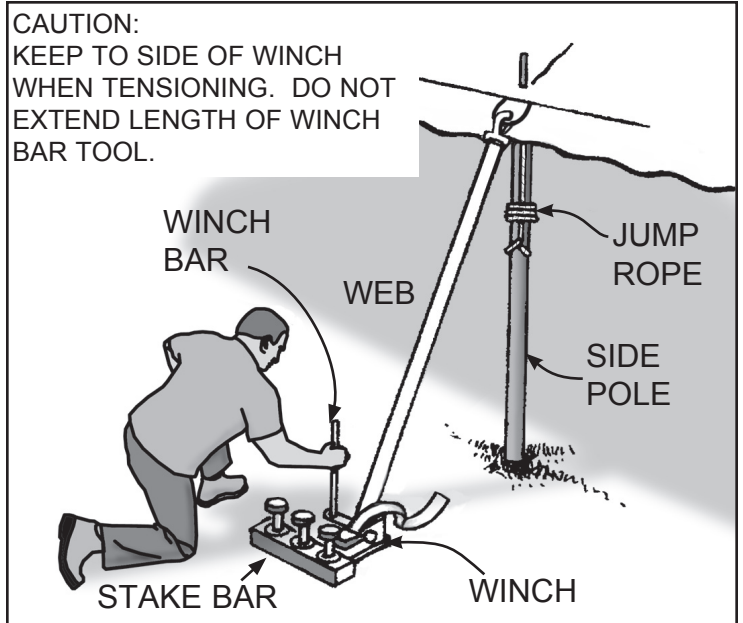

## 9 FINAL SIDE POLE ADJUSTMENT

With side poles standing vertical and bases at the marked side pole footprint locations, ratchet webs to tension the top evenly.

Due to changes in climactic conditions, periodic inspection and adjustment should be made.

Protective covers are recommended for all stakes and stake bars.

## 10 TAKE DOWN - USE EXTREME CAUTION REMOVING ALL POLES

1. Spread ground cover.
2. Loosen tension on all web winches.
3. Slant side poles inward.
4. Remove center and side poles.
5. Reverse installation steps.

### IMPORTANT

Check guys periodically for tightness and maintenance of good condition.

# SUPPLEMENTAL INSTRUCTIONS FOR TENTS WITH CENTER SECTIONS

USE WITH STEPS 1 THRU 8

## 1a MEASURE LAYOUT

Mark location of stake line, tent line and center poles. (See page 3)

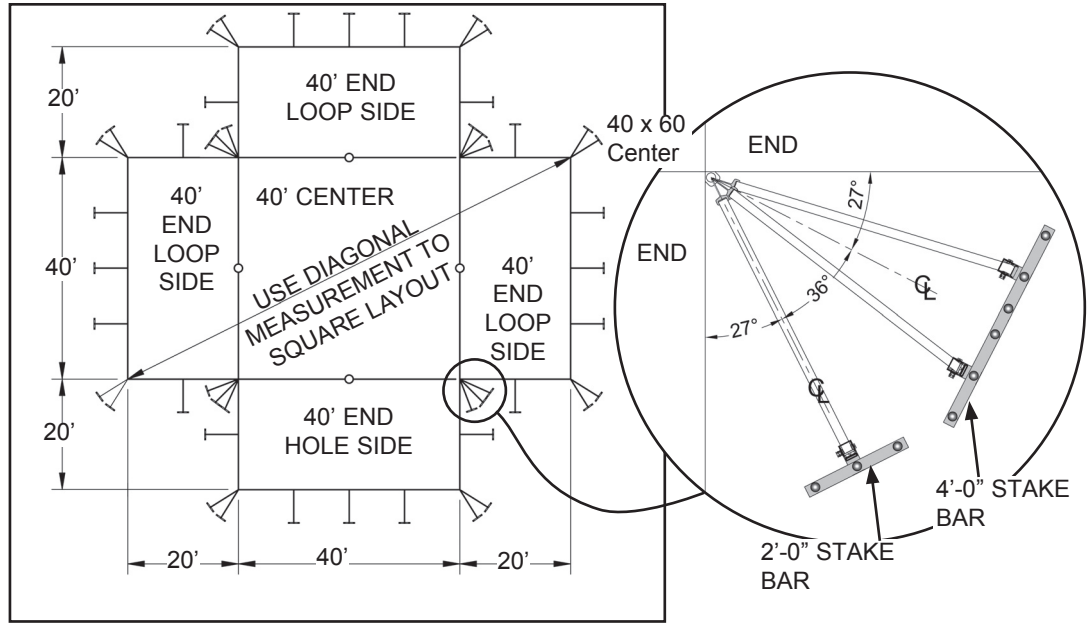

## 3a LACING

In addition to step #3, align plates and attach bolt, washers and eye nut.

Hook is not used at this location. Use (4) web guys (center plate and eye nut) to tie off at this location.

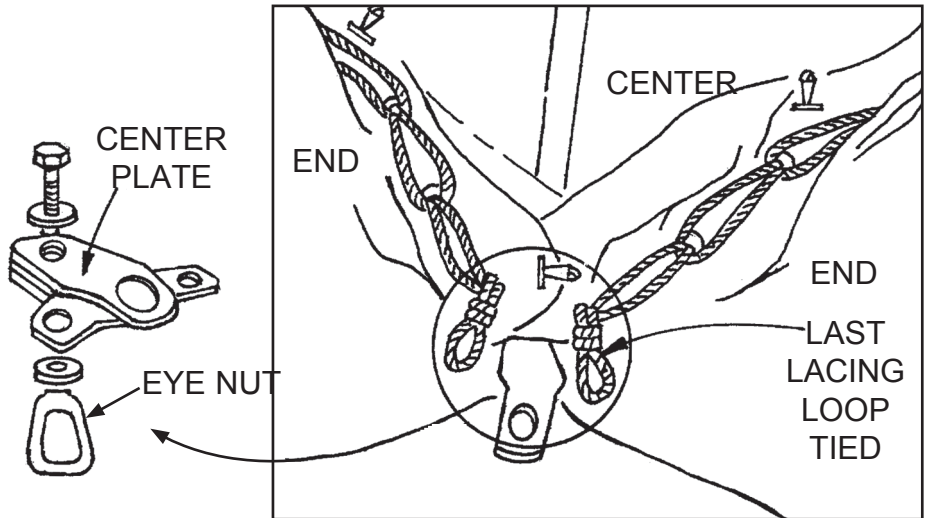

## 8a WINCH FOR TENSION

Use winches at center section lace where proper tension is needed for correct tie down and wrinkle free structure.

Auger cable straight down into ground.

**USE CAUTION WHEN OPERATING WINCH.**

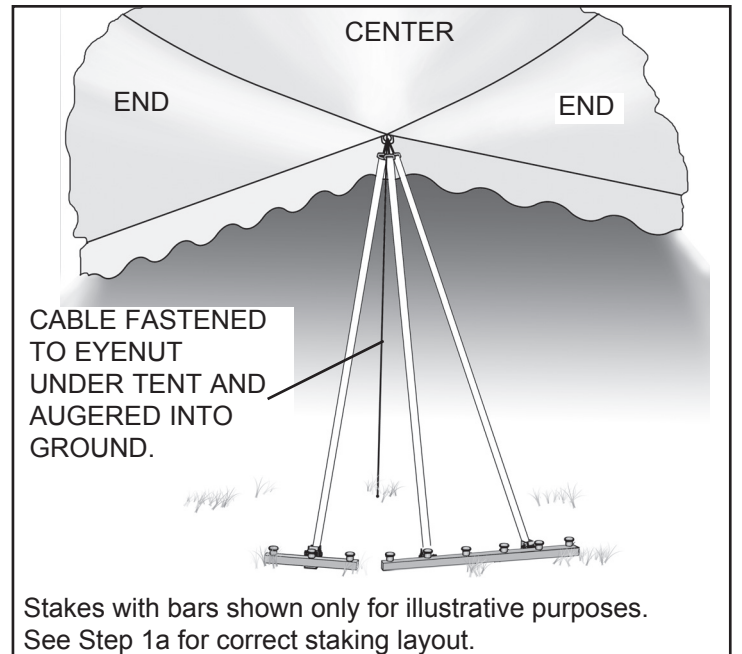



**PHONE NUMBER**  
812 · 867 · 2421

**FAX NUMBER**  
812 · 867 · 0547

Anchor products are of superior design and operate best within the parameters of these instructions. It is imperative that the instructions be carefully read and **COMPLETELY FOLLOWED**. Please read installation instructions before the installation or removal of this product. Installation instructions are available online at [www.anchorinc.com](http://www.anchorinc.com) or by calling 1-800-544-4445.

### **CAUTION:**

1. For each installation, the installer is solely responsible for evaluating the site and the proper securing method determined. Some soils require different staking or securing than that provided with the tent. Due to this variety of soil conditions, these are the manufacturer's suggested sequence of installation procedures. Anchor's responsibility is limited to the manufacture of the tent parts and materials. We are not responsible for methods that installers may choose to erect and secure the tent to the ground.
2. The number of stakes suggested in the installation instructions do not necessarily meet all or any relevant codes on the site of the tent installation. The number of stakes suggested **will, in many cases, keep the tent erected**, however, due to various soil conditions; these stakes will be insufficient **to keep the tent secure in high winds**. It is the tent installer's responsibility, not the manufacturer, to determine the appropriate number of stakes to meet the necessary wind loads on the site. Regardless of the number of stakes we suggest, we make no representation or warranty as to whether this specific number of stakes will meet the local tent code. Anchor does not, nor can it make any suggestions, representation, or warranties about the adequate staking required at each specific installation site. Staking information provided in the installation instructions **is not a suggestion about what is necessary to meet a site-specific load**.

**For additional important information, consult: "The IFAI Procedural Handbook For the Safe Installation and Maintenance of Tentage" and the IFAI Pocket Guide "Pullout Capacity of Tent Stakes", both available from the IFAI Tent Rental Division or on our website.**

3. Inasmuch as the weather is unpredictable, good judgment and common sense must be incorporated within installation guidelines. It is the responsibility of the tent installer/maintainer to determine the severity of the weather, proper time and method of installation and/or erection and disassembly. **Note: We recommend that snow and ice be removed from the tent surface as soon as possible because accumulation will damage the tent or fabric structure. Please consult with our Engineering Department about the maximum loads for each product.**

This product has been manufactured for use as a temporary structure. For the safety of all occupants, evacuation is recommended if threatening weather occurs, or if there is any doubt concerning the safe use of this product.

4. Proper safety equipment should be used at all times to insure a safe installation and take down. We suggest a careful evaluation be made to determine safety equipment needed, such as hard hats, steel-toe shoes, safety glasses and other as required. It is our desire that all installations are safe. Please be aware of hidden dangers both underground, i.e., gas lines, water lines, electrical lines, etc. and above the tent such as power lines and telephone lines.
5. Anchor stands behind its products in accordance with its standard Terms and Conditions of sale. A copy of our Terms and Conditions of Sale can be obtained by contacting Anchor at the telephone number and/or address on this document.